

Service Network:



英文版: 201305EV2.0



PI9000 series

High-performance vector control inverter



www.powtran.com

Powtran technology
-Professional manufacturer of frequency inverter based on the motor design and manufacture.

Contact

Dalian Powtran Technology Co.Ltd.Shenzhen Branch.
Address:No.75, Baomin 2nd Road, Xixiang Town,Baoan District, Shenzhen, China(518101)
Tel: 0086-755-29630738
Fax: 0086-755-29666485
Email: info@powtran.com
Website : www.powtran.com/www.powtran.net

Hotline:
400-0411-755



Contents

Contents.....	01-02
About Powtran.....	03-04
Company Profile.....	03
Honor.....	03
Certificates.....	04
Powtran Products.....	05-06
Products introduction.....	05
Performance.....	05
Capacity arrange.....	05
Application field.....	05
Product Instruction.....	07-08
Nameplate.....	07
Technical Features.....	08
Standard Specification.....	09-10
Technical Specification.....	11-12
Energy saving.....	13
Product Size.....	14-20
Product Size.....	14-16
Installation.....	17
Wiring.....	18-20
Terminal.....	21-22
Main circuit terminal.....	21
Control loop terminal.....	22
Keyboard Introduction.....	23
Quality & Research Management.....	24
Optional Parts.....	25-26

Energy saving, low carbon, environmental-friendly

We dedicate ourselves to provide global customers with frequency inverters which can be widely used for asynchronous and permanent magnet synchronous motors in different kinds of application.





Company Introduction

Powtran Technology as a national high-tech enterprise, set up Wuxi, Guangzhou and more than 30 offices with the center of Shenzhen and Dalian cities and established a worldwide network of R & D, production, logistics and service. Composing the advanced technology from Japan Toshiba and Taiwan brand, Powtran provides a series of energy saving and automatic & drive control products, products, such as frequency inverters(including special power supply), soft starters, AC servo drive system, energy saver, vehicle motor drive system. Powtran products are verified by international authoritative organizations and now export to more than 100 countries.

Company History

- 2012:Continuous 6 years of holding the "low voltage converter top ten domestic brand"
- 2011: Provincial electric drive engineering research center
- 2010: Ministry of science and technology innovation fund for the project
- 2009: National Top-new technical enterprise
- 2008: "The ten major energy conservation projects"
- 2007:The vice chairman of the association of frequency converter enterprise; PS7000 motor environmental protection energy efficient appliances, PI7900 electromagnetic stirring power be inspected by national authoritative organization
- 2006: Bear "Torch Plan", 863 Plan Projects , PI7000 series inverter passed GB12668 inspection and Provincial scientific and technological achievements appraisal
- 2005:America ABS approve; National authoritative organization verification
- 2004:ISO9001 Quality Certificate
- 2001:Powtran Dalian office established, National High and New technology enterprise
- 1997:TUV Germany approve & CE Europe approve

Certifications





Improve productivity

To reduce enterprise comprehensive energy costs

Production orientation:

Based on the lasted theory and technology of motor running and control, Powtran invent a new high performance vector control frequency inverter. Through decoupling the motor flux current and torque current, it can achieve high rapid response and high accuracy torque control, gain high precision with more wider range control in speed control and torque control as well.

Performance comparison:



Capacity range:

Power range: 0.4~550kW
 Maximum frequency: 600.0Hz
 Voltage level: 1-phase 220V
 3-phase 220V
 3-phase 380V
 3-phase 480V
 3-phase 690V

Application field:

Metallurgy, petroleum, chemical, textile, building material, coal, medicine, food, paper making, plastic, printing, hoist, washing, water supply, sewage treatment, etc
 Machine industry:
 Wire drawing machine, mixer, compressor, extruder, pump, air blower, grinder, conveyor, lifting machine, etc

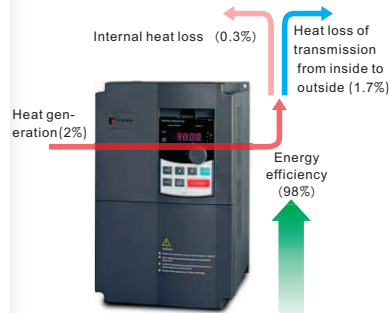
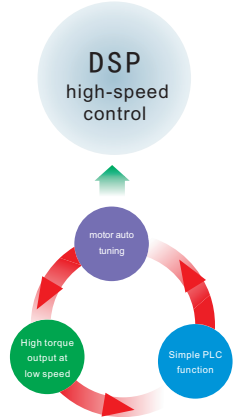

Focus on details & reliability

is our constant pursuit

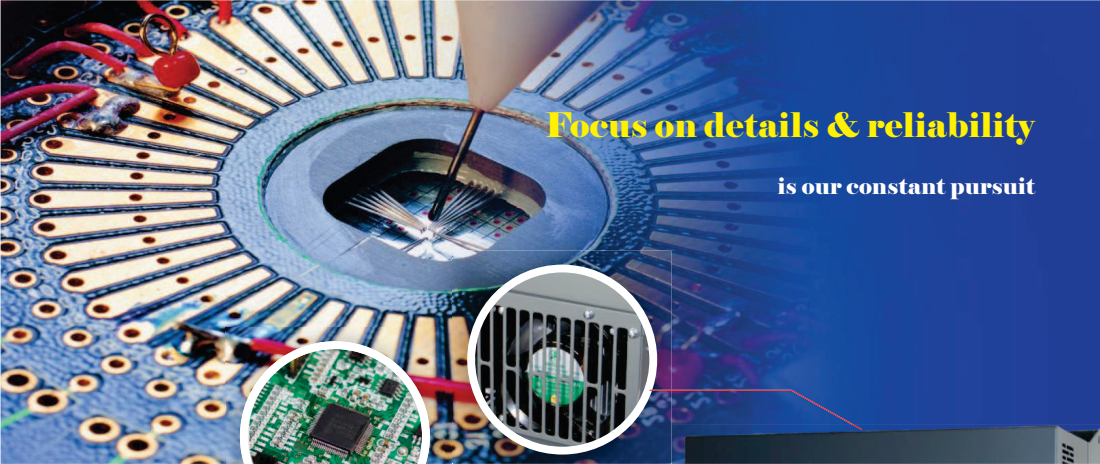

Optimized ventilation design, intelligent temperature control.

High quality DSP module



Reliable insulation design, ensure the safety of inverter

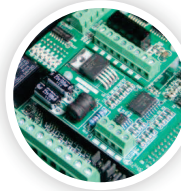

standard module design, flexible to expand more function.

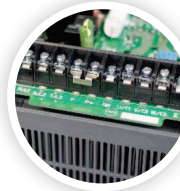

Convenient and safe terminal ports





More stable & convenient

This is PI9000

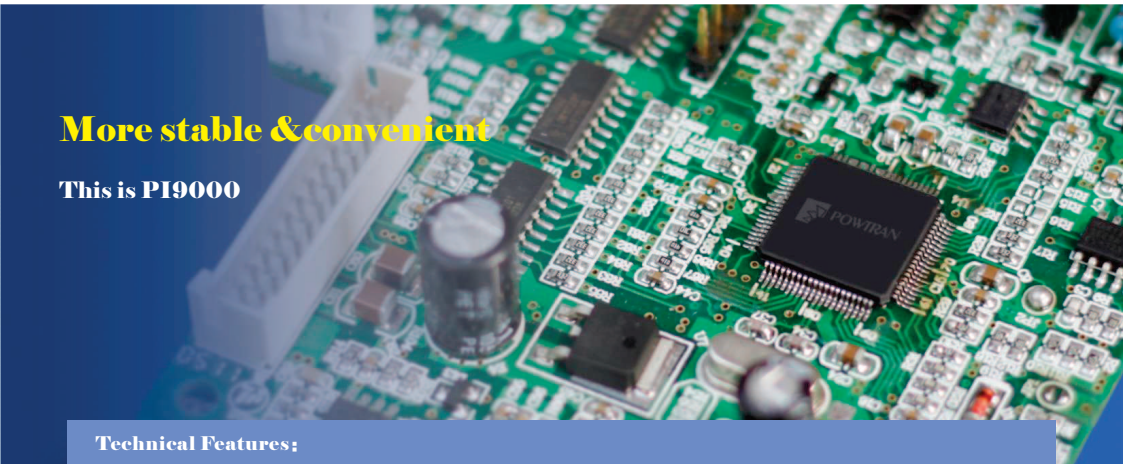

Nameplate instruction:

- inverter model →
- input rating →
- output rating →
- Serial No. & Bar Code →

普传科技	
TYPE	PI9100 7R5G3
SOURCE	3 φ 380V 50-60Hz
OUTPUT	7.5KW 17A 0.00-400.0Hz

ZPB1A0100001

Model Description:

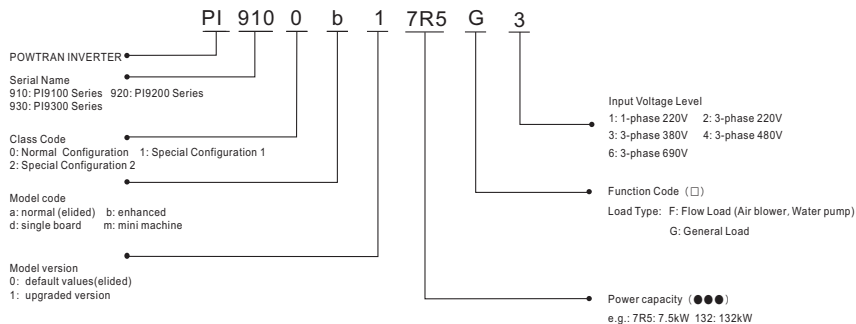

Technical Features:

<p>1. Based on 32-bit DSP and adopt an advanced vector control algorithm to realize a high-performance control.</p>	<p>2. Mode of speed control: Senseless Vector Control, Sensor Close Loop Vector Control, V/F control</p>	<p>3. Vector control in asynchronous and permanent synchronous motor is available feature motor parameter auto-tuning.</p>	<p>4. 150% torque when at low speed (0.5) running in the sensorless vector control mode.</p>
<p>5. Built in simple PLC function, 16 sections speed is available.</p>	<p>6. Multi-language OLED could display 3 parameter groups at the same time</p>	<p>7. Rotating freely with "one key shuttle keyboard"</p>	<p>8. Optimized ventilation design</p>
<p>9. Reliable insulation design, ensure the safety of inverter</p>	<p>10. Support the standard Modbus communication protocol</p>	<p>11. Strengthened coating, adapt to tough environment</p>	<p>12. Unique EMC design, minimized the radiating interference to power grid.</p> <p style="text-align: center;">EMC</p>



Standard specification:

Item		Specification
Power	Voltage and frequency levels	Single-phase 220,50/60Hz Three-phase 220V,50/60Hz Three-phase 380,50/60Hz Three-phase 480V,50/60Hz Three-phase 690V,50/60Hz
	Allowable fluctuation	Voltage:±10% Frequency:±5%
Control system	Control system	High performance vector control inverter based on DSP
	Output frequency	Vector control:0 to 300Hz V/F control:0 to 600Hz
	Control method	V/F control, vector control W/O PG, vector control W/ PG
	Automatic torque boost function	Realize low frequency (1Hz) and large output torque control under the V/F control mode.
	Acceleration/deceleration control	Straight or S-curve mode. Four times available and time range is 0.0 to 6500.0s.
	V/F curve mode	Linear,square root/m-th power,custom V/F curve
	Over load capability	G type:rated current 150% - 1 minute, rated current 180% - 2 seconds F type:rated current 120% - 1 minute, rated current 150% - 2 seconds
	Maximum frequency	Vector control:0 to 300Hz V/F control:0 to 600Hz
	Carrier Frequency	0.5 to 15kHz,automatically adjust carrier frequency according to the load characteristics.
	Input frequency resolution	Digital setting: 0.01Hz Analog setting: maximum frequency×0.025%
Start torque	G type: 0.5Hz/150% (vector control W/O PG) F type: 0.5Hz/100% (vector control W/O PG)	
Speed range	1:100 (vector control W/O PG) 1:1000 (vector control W/ PG)	
Steady-speed precision	Vector control W/O PG: ≤ ± 0.5% (rated synchronous speed) Vector control W/ PG: ≤ ± 0.02% (rated synchronous speed)	
Speed control accuracy	Vector control W/O PG ≤ ± 0.3% (rated synchronous speed)	
Torque response	≤ 40ms (vector control W/O PG)	
Torque boost	Automatic torque boost; manual torque boost(0.1% to 30.0%)	
DC braking	DC braking frequency: 0.0Hz to max. frequency, braking time: 0.0 to 36.0 seconds, braking current value: 0.0~100.0s	
Jogging control	Jog Frequency Range: 0.00Hz to max. frequency; Jog Ac/deceleration time: 0.0s~6500.0s	
Multi-speed operation	Achieve up to 16-speed operation through the control terminal	
Built-in PID	Easy to realize closed-loop control system for the process control.	
Automatic voltage regulation(AVR)	Automatically maintain a constant output voltage when the voltage of electricity grid changes	
Torque limit and control	"Excavator" feature - torque is automatically limited during the operation to prevent frequent overcurrent trip,the closed-loop vector mode is used to control torque.	
Personalization function	Self-inspection of peripherals after power-on	After powering on, peripheral equipment will perform safety testing, such as ground, short circuit,etc.
	Common DC bus function	Multiple inverters can use a common DC bus.
	Cycle-by-cycle current limiting	The current limiting algorithm is used to reduce the inverter overcurrent probability, and improve whole unit anti-interference capability.
	Timing control	Timing control function: time setting range(0h to 65535h).

Standard specification:

Item		Specification	
Running	input signal	Running method	Keyboard/terminal/communication
		Frequency setting	10 frequency settings available, including adjustable DC(0 to 10V),adjustable DC(0 to 20mA), panel potentiometer, etc.
		Start signal	Rotate forward/reverse
		Multi-speed	At most 16-speed can be set(run by using the multi-function terminals or program)
		Emergency stop	Interrupt controller output
		Wobble run	Process control run
	output signal	Fault reset	When the protection function is active, you can automatically or manually reset the fault condition. Including DC(0 to 10V), DC(0 to 20mA)
		PID feedback signal	
		Running status	Motor status display, stop, ac/deceleration, constant speed, program running status.
		Fault output	Contact output - AC 250V 5A, DC 30V 5A
Run function	Analog output	Two-way analog output, 16 signals can be selected such as frequency,current,voltage and other, output signal range (0 to 10V / 0 to 20mA).	
	Output signal	At most 3-way output,there are 40 signals each way	
	DC current braking	Limit frequency,jump frequency,frequency compensation,auto-tuning, PID control	
	Running command channel	Built-in PID regulates braking current to ensure sufficient braking torque under no overcurrent condition. Three channels: operation panel,control terminals and serial communication port. They can be switched through a variety of ways.	
	Frequency source	Total 5 frequency sources: digital, analog voltage, analog current, multi-speed and serial port. They can be switched through a variety of ways.	
Protection function	Input terminals	6 digital input terminals, compatible with active PNP or NPN input mode, one of them can be for high-speed pulse input(0 to 100KHZ square wave); 2 analog input terminals for voltage or current input.	
	Output terminals	2 digital output terminals, one of them can be for high-speed pulse output(0 to 100KHZ square wave); one relay output terminal; 2 analog output terminals respectively for optional range (0 to 20mA or 0 to 10V),they can be used to set frequency, output frequency, speed and other physical parameters.	
display	Inverter protection	Overvoltage protection, undervoltage protection, overcurrent protection, overload protection, overheat protection, overcurrent stall protection, overvoltage stall protection, losing-phase protection (optional), external fault, communication error, PID feedback signal abnormalities, PG failure and short circuit to ground protection.	
	IGBT temperature display	Displays current temperature IGBT	
	Inverter fan control	Can be set	
	Instantaneous power-down restart	Less than 15 milliseconds: continuous operation. More than 15 milliseconds: automatic detection of motor speed, instantaneous power-down restart.	
	Speed start tracking method	The inverter automatically tracks motor speed after it starts	
Communication	Parameter protection function	Protect inverter parameters by setting administrator Password and decoding	
	LED/OLED display keyboard	Monitoring objects including : running frequency, set frequency, actual motor current, DC bus voltage, output voltage, actual motor speed, cumulative running time, IGBT temperature, PID reference value, PID feedback value, input terminal status, output terminal status, analog AI1 value, analog AI2 value, current stage of multi-speed, torque set value.	
	LED display	At most save 3 error message, and the time, type, voltage, current, frequency and work status can be queried when the failure is occurred.	
	OLED display	Display parameters	
Environment	Copy parameter	Optional, prompts operation content in Chinese/English text.	
	Key lock and function selection	Quickly copy parameters by using the special keyboard (only for OLED)	
	Environment temperature	Lock part or all of keys, define the function scope of some keys to prevent misuse.	
Product standard	RS485/RS232	The optional completely isolated RS485/RS232 communication module can communicate with the host computer.	
	Environment humidity	-10 °C to 40 °C (temperature at 40 °C to 50 °C, please derating for use) -20 °C to 65 °C	
Product standard	Height and vibration	Less than 90% R.H, does not exceed 90% R.H	
	Application sites	Below 1000m, below 5.9m/s ² (= 0.6g)	
Product standard	Altitude	Indoor where no sunlight or corrosive, explosive gas and water vapor, dust, flammable gas, oil mist, water vapor, drip or salt, etc.	
	Pollution degree	Below 1000m	
Product standard	Product adopts safety standards.	2	
	Product adopts EMC standards.	IEC61800-5-1:2007 IEC61800-3:2005	
Product standard	Cooling method	Forced air cooling and natural air cooling	



Technical specifications:

Inverter model	rated output power	rated input current	rated output current	match motor	base No.	input voltage	
PI9100-0R4G1	0.4	5.4	2.5	0.4	9S2	1-phase 220V ±10%	
PI9100-0R7G1	0.75	8.2	4	0.75	9S2		
PI9100-1R5G1	1.5	14	7	1.5	9S2		
PI9100-2R2G1	2.2	23	10	2.2	9S3		
PI9100-004G1	4.0	35	16	4.0	9S3		
PI9200-5R5G1	5.5	50	25	5.5	9L1		
PI9100-0R4G2	0.4	4.1	2.5	0.4	9S2	3-phase 220V ±10%	
PI9100-0R7G2	0.75	5.3	4	0.75	9S2		
PI9100-1R5G2	1.5	8.0	7	1.5	9S2		
PI9100-2R2G2	2.2	11.8	10	2.2	9S3		
PI9100-004G2	4.0	18.1	16	4.0	9S3		
PI9200-5R5G2	5.5	28	25	5.5	9L1		
PI9200-7R5G2	7.5	37.1	32	7.5	9L1		
PI9200-011G2	11	49.8	45	11	9L1		
PI9200-015G2	15.0	65.4	60	15.0	9L2		
PI9200-018G2	18.5	81.6	75	18.5	9L2		
PI9200-022G2	22.0	97.7	90	22.0	9L3		
PI9200-030G2	30.0	122.1	110	30.0	9L3		
PI9200-037G2	37.0	157.4	152	37.0	9L3		
PI9200-045G2	45.0	185.3	176	45.0	9L4		
PI9200-055G2	55.0	214	210	55.0	9L4		
PI9200-075G2	75	307	304	75	9L4		
PI9100-0R7G3	0.75	4.3	2.5	0.75	9S2		3-phase 380V ±10%
PI9100-1R5G3	1.5	5.0	3.8	1.5	9S2		
PI9100-2R2G3	2.2	5.8	5.1	2.2	9S2		
PI9100-004G3	4.0	10.5	9	4.0	9S3		
PI9100-5R5G3	5.5	14.6	13	5.5	9S3		
PI9100-7R5G3	7.5	20.5	17	7.5	9S4		
PI9200-011G3/PI9200-011F3/PI9200-015F3	11/11/15	26/26/35	25/25/32	11/11/15	9L1		
PI9200-015G3/PI9200-018F3	15/18.5	35/38.5	32/37	15/18.5	9L1		
PI9200-018G3/PI9200-022F3	18.5/22	38.5/46.5	37/45	18.5/22	9L2		
PI9200-022G3/PI9200-030F3	22/30	46.5/62	45/60	22/30	9L2		
PI9200-030G3/PI9200-037F3	30/37	62/76	60/75	30/37	9L3		
PI9200-037G3/PI9200-045F3	37/45	76/91	75/93	37/45	9L3		
PI9200-045G3/PI9200-055F3	45/55	91/112	93/110	45/55	9L4		
PI9200-055G3/PI9200-075F3	55/75	112/157	110/150	55/75	9L4		
PI9200-075G3/PI9200-093F3	75/93	157/180	150/176	75/93	9L4		
PI9200-093G3/PI9200-110F3	93/110	180/214	176/210	93/110	9L5		
PI9200-110G3/PI9200-132F3	110/132	214/256	210/253	110/132	9L5		
PI9200-132G3/PI9200-160F3	132/160	256/307	253/304	132/160	9L6		
PI9200-160G3/PI9200-187F3	160/187	307/345	304/340	160/187	9L6		
PI9300-187G3/PI9300-200F3	187/200	345/385	340/380	187/200	9C1		
PI9300-187G3/PI9300-200F3	187/200	345/385	340/380	187/200	9C2		
PI9300-200G3/PI9300-220F3	200/220	385/430	380/426	200/220	9C1		
PI9300-200G3/PI9300-220F3	200/220	385/430	380/426	200/220	9C2		
PI9300-220G3/PI9300-250F3	220/250	430/468	426/465	220/250	9C1		
PI9300-220G3/PI9300-250F3	220/250	430/468	426/465	220/250	9C2		
PI9300-250G3/PI9300-280F3	250/280	468/525	465/520	250/280	9C3		
PI9300-280G3/PI9300-315F3	280/315	525/590	520/585	280/315	9C3		
PI9300-315G3/PI9300-355F3	315/355	590/665	585/650	315/355	9C3		
PI9300-355G3/PI9300-400F3	355/400	665/785	650/725	355/400	9C3		

Technical specifications:

Inverter model	base No.	rated output power	rated input current	rated output current	match motor	input voltage
PI9100-0R7G4	9S2	0.75	4.1	2.5	0.75	3-phase 480V ±10%
PI9100-1R5G4	9S2	1.5	4.9	3.7	1.5	
PI9100-2R2G4	9S2	2.2	5.7	5.0	2.2	
PI9100-004G4	9S3	4.0	9.4	8	4.0	
PI9100-5R5G4/PI9100-5R5F4	9S3	5.5	12.5	11	5.5	
PI9100-7R5G4/PI9100-7R5F4	9S4	7.5	18.3	15	7.5	
PI9200-011G4/PI9200-011F4/PI9200-015F4	9L1	11/11/15	23.1/23.1/29.8	22/22/27	11/11/15	
PI9200-015G4/PI9200-018F4	9L1	15/18.5	29.8/35.7	27/34	15/18.5	
PI9200-018G4/PI9200-022F4	9L2	18.5/22	35.7/41.7	34/40	18.5/22	
PI9200-022G4/PI9200-030F4	9L2	22/30	41.7/57.4	40/55	22/30	
PI9200-030G4/PI9200-037F4	9L3	30/37	57.4/66.5	55/65	30/37	
PI9200-037G4/PI9200-045F4	9L3	37/45	66.5/81.7	65/80	37/45	
PI9200-045G4/PI9200-055F4	9L4	45/55	81.7/101.9	80/100	45/55	
PI9200-055G4/PI9200-075F4	9L4	55/75	101.9/137.4	100/130	55/75	
PI9200-075G4/PI9200-093F4	9L4	75/93	137.4/151.8	130/147	75/93	
PI9200-093G4/PI9200-110F4	9L5	93/110	151.8/185.3	147/180	93/110	
PI9200-110G4/PI9200-132F4	9L5	110/132	185.3/220.7	180/216	110/132	
PI9200-132G4/PI9200-160F4	9L6	132/160	220.7/264.2	216/259	132/160	
PI9200-160G4/PI9200-187F4	9L6	160/187	264.2/309.4	259/300	160/187	
PI9300-187G4/PI9300-200F4	9C1	187/200	309.4/334.4	300/328	187/200	
PI9300-187G4/PI9300-200F4	9C2	187/200	309.4/334.4	300/328	187/200	
PI9300-200G4/PI9300-220F4	9C1	200/220	334.4/363.9	328/358	200/220	
PI9300-200G4/PI9300-220F4	9C2	200/220	334.4/363.9	328/358	200/220	
PI9300-220G4/PI9300-250F4	9C1	220/250	363.9/407.9	358/400	220/250	
PI9300-220G4/PI9300-250F4	9C2	220/250	363.9/407.9	358/400	220/250	
PI9300-250G4/PI9300-280F4	9C3	250/280	407.9/457.4	400/449	250/280	
PI9300-280G4/PI9300-315F4	9C3	280/315	457.4/533.2	449/516	280/315	
PI9300-315G4/PI9300-355F4	9C3	315/355	533.2/623.3	516/570	315/355	
PI9300-355G4/PI9300-400F4	9C3	355/400	623.3/706.9	570/650	355/400	
PI9200-055G6/PI9200-075F6	9L4	55/75	70/90	62/85	55/75	3-phase 690V ±10%
PI9200-075G6/PI9200-093F6	9L4	75/93	90/105	85/102	75/93	
PI9200-093G6/PI9200-110F6	9L5	93/110	105/130	102/125	93/110	
PI9200-110G6/PI9200-132F6	9L5	110/132	130/170	125/150	110/132	
PI9200-132G6/PI9200-160F6	9L6	132/160	170/200	150/175	132/160	
PI9200-160G6/PI9200-187F6	9L6	160/187	200/210	175/198	160/187	
PI9300-187G6/PI9300-200F6	9C2	187/200	210/235	198/215	187/200	
PI9300-187G6/PI9300-200F6	9C1	187/200	210/235	198/215	187/200	
PI9300-200G6/PI9300-220F6	9C2	200/220	235/247	215/245	200/220	
PI9300-200G6/PI9300-220F6	9C1	200/220	235/247	215/245	200/220	
PI9300-220G6/PI9300-250F6	9C2	220/250	247/265	245/260	220/250	
PI9300-220G6/PI9300-250F6	9C1	220/250	247/265	245/260	220/250	
PI9300-250G6/PI9300-280F6	9C3	250/280	265/305	260/299	250/280	
PI9300-280G6/PI9300-315F6	9C3	280/315	305/350	299/330	280/315	
PI9300-315G6/PI9300-355F6	9C3	315/355	350/382	330/374	315/355	
PI9300-355G6/PI9300-400F6	9C3	355/400	382/435	374/410	355/400	
PI9300-400G6/PI9300-450F6	9C3	400/450	435/490	410/465	400/450	
PI9300-450G6/PI9300-500F6	9C3	450/500	490/595	465/550	450/500	
PI9300-500G6	9C3	500	595	550	500	
PI9300-550G6	9C3	550	605	590	550	

*)Remarks: 9300 9C1 and 9C2 has the same power range, with the following differences:
A: Main power cable layout is different, 9C1 is to power in from upside and output from the underside, 9C2 is to power in from the left side and output from the right side
B: 9C1's bottom fix base is removable C: Construction and dimension is different



Fast return on investment, Low Maintenance cost.

Remarkable enhancement on reliability and continuously running



Energy-saving:

Advanced energy saving technology

Use energy saving control of frequency converter to realize high efficient running of asynchronous motor

Saving much more energy on synchronous motor

The energy saving control of the inverter combine with high efficient synchronous motor together can gain super energy saving compare to asynchronous motor .

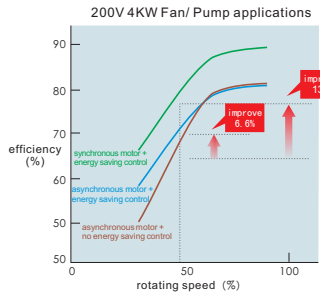

Pi9000 Energy-saving effect sample

100 sets, 4 KW fan service in air condition application. Electricity price is 0.11USD/KWH. Service time :365 days per year.

A asynchronous motor + frequency inverter control
Energy consumption about 1,903,100 KWH
Cost of energy about 211,428 USD.

B synchronous motor + frequency inverter control
Energy consumption about 1,754,600 KWH
Cost of energy about 194,929USD.

energy saving per year
energy saving : about 148,500KWH.
Saving cost of energy about 16,499USD.

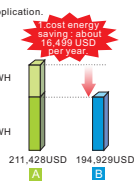

Environmental resistance:

Corrosion resistance, resistance to dust, resistance to vibration and resistance to environment, the strengthening of the product and meanwhile with dust, drip-proof type taking protection structure.

Pass ROSH

Standard product pass ROHS(European specific harmful substance use restrictions).

Reduce noise

Use Swing PWN to inhibition of electromagnetic interference and reduce the harsh noise



Suppress the high order harmonic in grid.

Built in DC reactor use for suppress high order harmonic. (Optional from 22KW to 160KW, standard built in from 187KW and above)

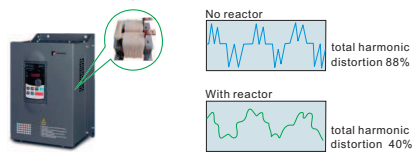

Specifications (plastic housing: 9S2/9S3/9S4)

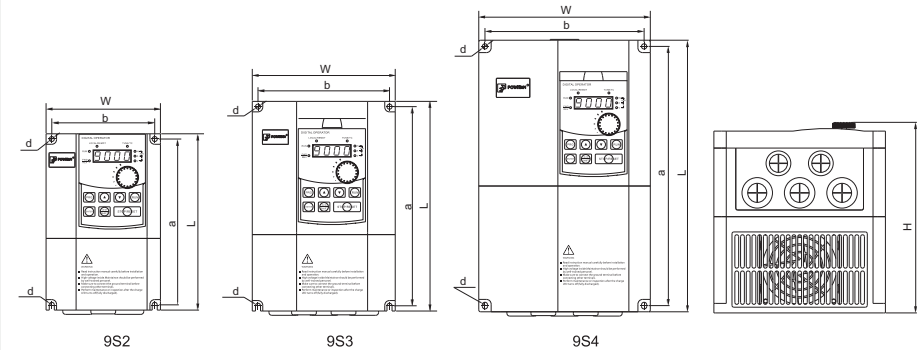

Base No.	Power(KW)	Voltage(V)	Current(A)	Shape dimensions(L*W*Hmm)	Installation dimensions(a*b dmm)
9S2	0.4~1.5	1 phase 220	2.5~7	185 120 178.5	174 108 Ø5.3
	0.4~1.5	3 phase 220	2.5~7		
	0.75~2.2	3 phase 380	2.5~5.1		
	0.75~2.2	3 phase 480	2.5~5.0		
9S3	2.2~4.0	1 phase 220	10~16	220 150 185.5	209 138 Ø5.3
	2.2~4.0	3 phase 220	10~16		
	4.0~5.5	3 phase 380	9~13		
	4.0~5.5	3 phase 480	8~11		
9S4	7.5	3 phase 380	17	285 180 200	272 167 Ø5.5
	7.5	3 phase 480	15		



Specification:

(wall-mounted metal housing, wiring layout from left to right 9L1—9L6)

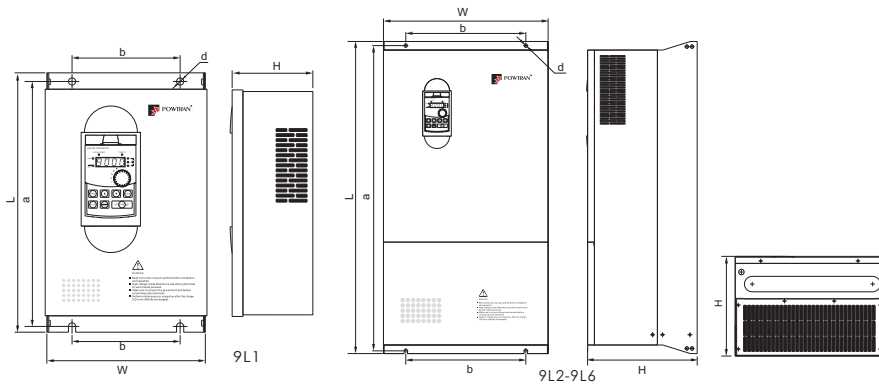

Base No.	Power(KW)	Voltage(V)	Current(A)	Shape dimensions(L*W*Hmm)	Installation dimensions(a*b dmm)
9L1	5.5	1 phase220	25	360 x 220 x 210	340 x 150 Ø10
	5.5~11	3 phase220	25~45		
	11~15	3 phase380	25~32		
	11~15	3 phase480	22~27		
9L2	15~18.5	3 phase220	60~75	435 x 225 x 242	415 x 165 Ø10
	18.5~22	3 phase380	37~45		
	18.5~22	3 phase480	34~40		
9L3	22~37	3 phase220	90~152	480 x 296 x 246	460 x 200 Ø10
	30~37	3 phase380	60~75		
	30~37	3 phase480	55~65		
9L4	45~75	3 phase220	176~304	660 x 364 x 280	640 x 250 Ø10
	45~75	3 phase380	93~150		
	45~75	3 phase480	80~130		
	55~75	3 phase690	62~85		
9L5	93~110	3 phase380	176~210	710 x 453 x 280	690 x 350 Ø10
	93~110	3 phase480	147~180		
	93~110	3 phase690	102~125		
9L6	132~160	3 phase380	253~304	910 x 480 x 323	890 x 350 Ø10
	132~160	3 phase480	216~259		
	132~160	3 phase690	150~175		

Specification:

(floor type with metal housing , wiring layout from left to right 9C1—9C3)

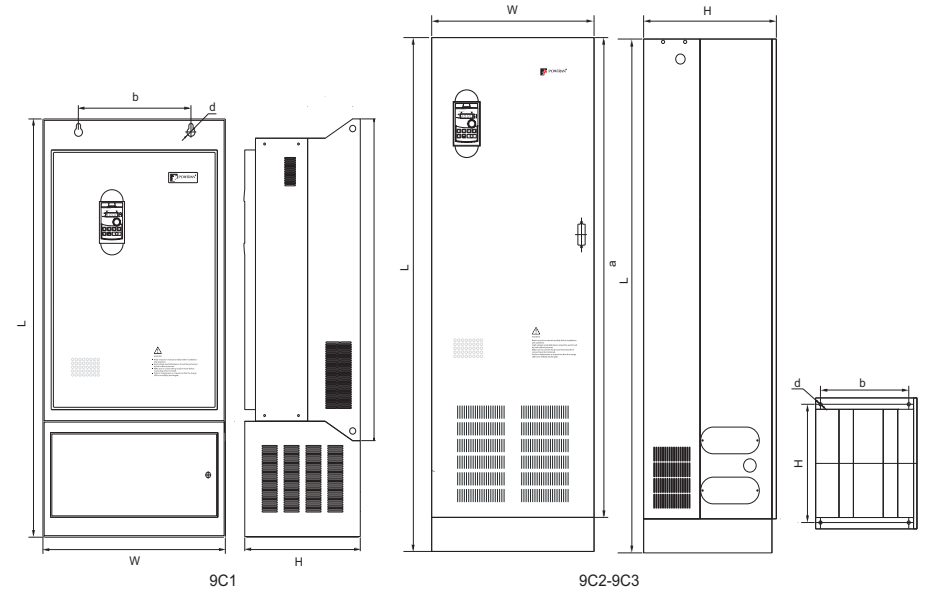

Base No.	Power(KW)	Voltage(V)	Current(A)	Shape dimensions(L*W*Hmm)	Installation dimensions(a*b dmm)
9C1	187~220	3 phase380	340~426	1300 x 600 x 380	550 x 280 Ø13
	187~220	3 phase480	300~358		
	187~220	3 phase690	198~245		
9C2	187~220	3 phase380	340~426	1540 x 525 x 421	464.5 x 367 Ø13
	187~220	3 phase480	300~358		
	187~220	3 phase690	198~245		
9C3	250~355	3 phase380	465~650	1698 x 851 x 470	640 x 260 Ø13
	250~355	3 phase480	400~570		
	250~550	3 phase690	260~590		



Installation:

Installation direction and Vacancy

The inverter shall be installed in the room where it is well ventilated, the wall-mounted installation shall be adopted, and the inverter must keep enough space around adjacent items or baffle (wall). As shown below figure:

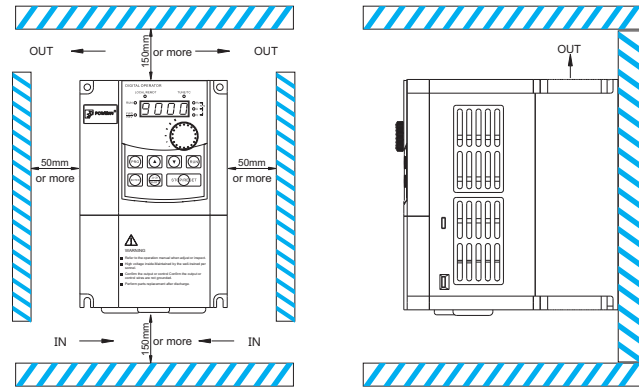

Environment:

Working conditions should be in comply with the regulations of IEC60721-3-3 level 3k3 and GB/T3859, 1 section 2.

environment temperature	-10℃--40℃ (when temperature is between 40-50℃, please consider degrading.)
Storage temperature	+20℃--65℃
Humidity	below 90% RH
Height and Vibration	below 1000m ,below 5.9m/s2(equals 0.6g)
Application field	indoor, no solar radiation, no corrosive or explosive gas or steam, no dust or combustible gas, oil, dropping water, salt.
Altitude	below 1000m.
Class of pollution	2
protection class	IP20

Mechanical Installation :

Install on solid indoor basement, there should not be severe impact on ventilation or cooling system in the installation area or additional enclosure. Air-conditioner can be allocated to enhance CDM/BDM. Other installation condition should take special consideration, and manufacturer should offer technical explanation and consulting advices. For fixed devices, vibration should maintain within the maximum of IEC60721 class 3M1.

Wiring

Frequency inverter wiring are divided into main circuit and control circuit two parts. Customers must follow the wiring diagram in the below correctly

Wiring diagram: 11kW and below

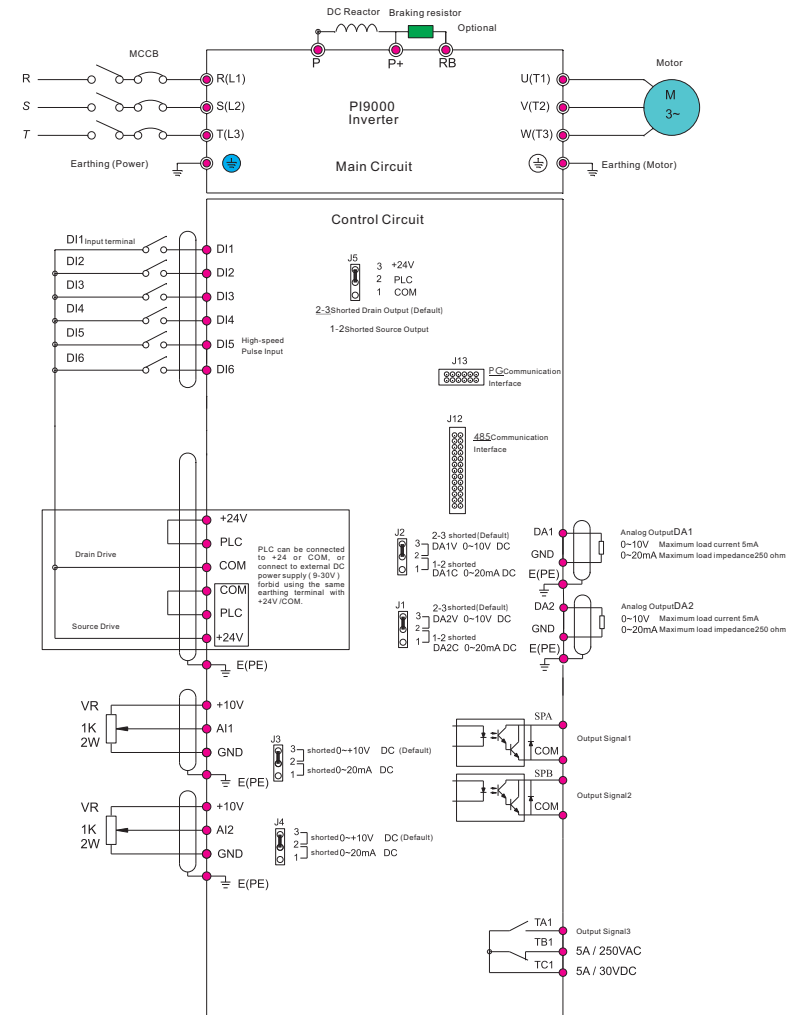



Wiring diagram : 11KW-15KW

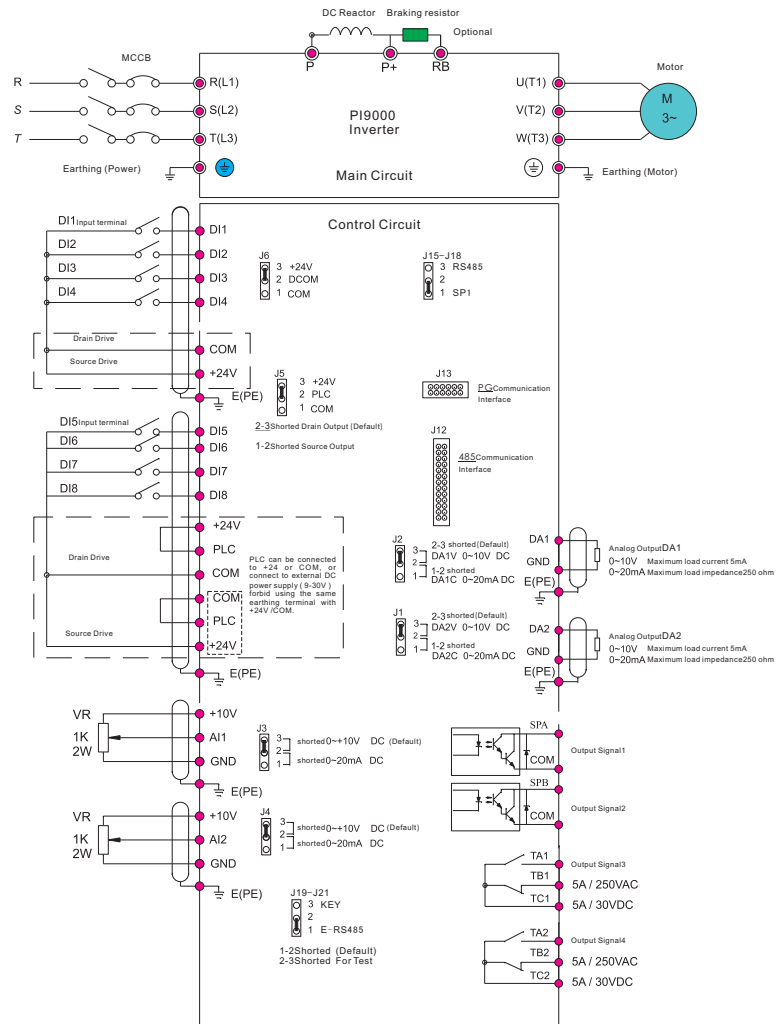

Wiring diagram : 18.5KW-355KW

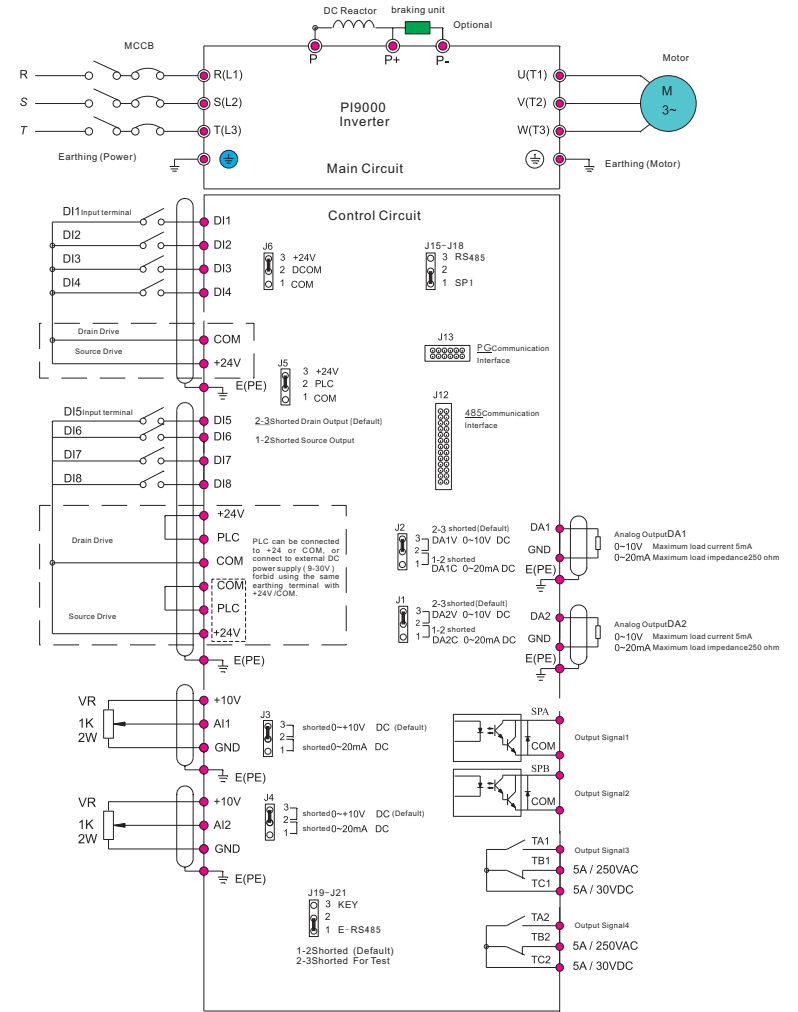



Terminals Description :

Below 7.5KW(380V) Main Circuit Terminals

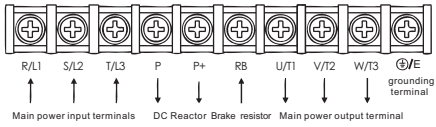

Note: The above power classifications are for G type inverter.

11KW-15KW (380V) Main Circuit Terminals

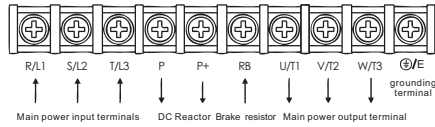

Note: The above power classifications are for G type inverter.

18.5KW-355KW (380V) Main Circuit Terminals (Left input right output)

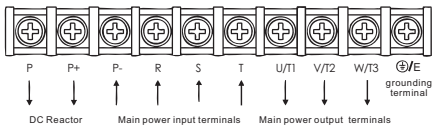

45KW-250KW (380V) Main Circuit Terminals (Up input down output)

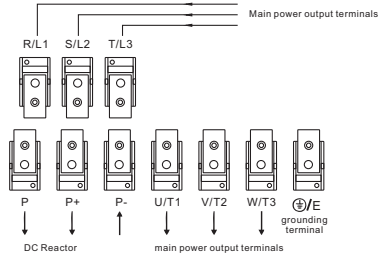

Note: P/P+ Standard setting is short circuit, if it is with external Dc Reactor , please disconnect and then connect it.

Terminal Function

Terminal	Name	Functions
R/L1 S/L2 T/L3	Inverter input terminals	Connect to three-phase power supply, single-phase connects to R, T
⊕/E	Grounding terminal	Connect to ground
P+, RB	Braking resistor terminals	Connect to braking resistor
U/T1 V/T2 W/T3	Output terminals	Connect to three-phase motor
P+, P-	DC bus output terminals	Connect to braking unit
P, P+	DC reactor terminals	Connect to DC reactor(remove the shorting block)

Terminals Description :

9KLCB Control circuit terminal

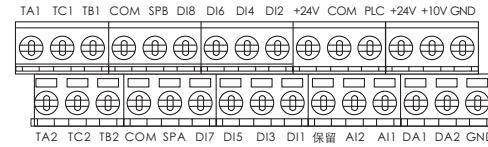

9KSCB Control circuit terminal

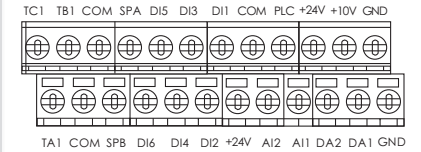

Description of control circuit terminals

Category	Symbol	Name	Function
Power supply	+10V-GND	External +10V power supply	Output +10V power supply, maximum output current: 10mA Generally it is used as power supply of external potentiometer, potentiometer resistance range: 1kΩ to 5kΩ
	+24V-COM	External+24V power supply	Output +24V power supply, generally it is used as power supply of digital input and output terminals and external sensor. Maximum output current: 200mA
	PLC	External power input terminal	When external signal is used to drive, please unplug J5 jumpers ,PLC must be connected to external power supply, and to +24V (default).
Analog input	AI1-GND	Analog input terminal 1	1. Input range:(DC 0V to 10V/0~20mA), depends on the selected J3 jumper on control panel. 2. Input impedance: 22kΩ with voltage input, 500Ω with current input.
	AI2-GND	Analog input terminal 2	1. Input range:(DC 0V to 10V/0~20mA), depends on the selected J4 jumper on control panel. 2. Input impedance: 22kΩ with voltage input, 500Ω with current input.
Digital input	DI1 DI2 DI3 DI4 DI5 DI6 DI7 DI8	Digital input 1 Digital input 2 Digital input 3 Digital input 4 Digital input 5 Digital input 6 Digital input 7 Digital input 8	1. Opto-coupler isolation, compatible with bipolar input 2. Input impedance: 2.4kΩ 3. Voltage range with level input: 9V to 30V 4. below 11KW: (DI1 to DI6)drive manner is controlled by J5, when external power supply is used to drive, please unplug J5 jumpers , 5. below 11KW: (DI1 to DI4)drive manner is controlled by J6, (DI5 to DI8)drive manner is controlled by J5.when external power supply is used to drive, please unplug J5 jumpers .
	DI5	High-speed pulse input terminals	DI5 can also be used as high-speed pulse input channels. Maximum input frequency: 100kHz
Analog output	DA1-GND	Analog output 1	The selected J2 jumper on control panel determines voltage or current output. Output voltage range: 0V to 10V , output current range: 0mA to 20mA
	DA1-GND	Analog output 2	The selected J1 jumper on control panel determines voltage or current output. Output voltage range: 0V to 10V , output current range: 0mA to 20mA
Digital output	SPA-COM SPB-COM	Digital output 1 Digital output 2	Opto-coupler isolation, bipolar open collector output Output voltage range: 0V to 24V , output current range: 0mA to 50mA
	SPB-COM	High-speed pulse output	Subject to function code(U5.00)'SPB terminal output mode selection' As a high-speed pulse output, the highest frequency up to 100kHz;
relay output	T/A1-T/C1 T/B1-T/C1	Normally open terminal Normally closed terminal	Contactor drive capacity: AC250V, 3A, COSφ = 0.4.
	J12 J13	485 card interface PG card interface	26 pin terminal 12 pin terminal



LED and OLED multi-function control keyboard

Multinational language humanized display menu
 Highlight OLED shows three groups of state parameter at the same time
 Use simple mode of operation
 Unique "one key to shuttle" design



Optional Components JP6E93 JP6E9300 keyboard (LED)

Operating keyboard: button key description

Sign	name	function
	Parameter Setting/ Exit Key	Enter top menu parameter change status Exit from function option change Return to status display menu from sub-menu or function option menu
	Shift Key	Select circularly parameters under run or stop interface; select parameters when modifying the parameters.
	Ascending Key	Data or function code ascending
	Decending Key	Data or function code decending
	Run Key	Used for running operation in the keyboard mode.
	Stop/Reset Key	Press the key to stop running in running status; press the key to reset in fault alarm status, can be used to reset the operation, the key is subject to function code U7.00.
	Enter Key	Enter into levels of menu screen, confirm settings.
	Keyboard potentiometer	F0.03 is set to 4, keyboard potentiometer is used to set the running frequency.

Quality and R&D management:

Quality management operation standard: ISO9001

Quality control management system: Research and development of quality management, supplier quality management, manufacturing quality management, service quality management

Information management system: Kingdee K3 WISE V13.0 enterprise resource planning management system, CRM customer management system, PLM product life cycle management system, Bar code management product quality traceability System, OA collaborative work system, Electronic post office management system



Motor control laboratory



constant temperature experimental facilities



Vibration test bench



Electronic measuring instrument



600MHz oscilloscope



Power analyzer and dynamometer controller



Fluke thermal imager



DC test



Semi-automatic test



aging test



automatic test with load



PCB burn-in test



Peripheral equipment:

Purpose	Name	Specification
Protect frequency inverter wiring	Wiring breaker or leakage protector	To protect frequency inverter connection, please set wiring breaker or leakage protector by the side of power supply. Please use preventing ultra-harmonics leakage protector.
Prevent braking resistor burning-out	AC contactor	To prevent braking resistor burning-out when connecting, please set AC contactor, meanwhile, please connect surge absorber on the coil.
Preventing switching surge leaking out	Surge absorber	Surge absorber absorbing electromagnetic contactor and control relay switching surge, please install surge absorber on the electromagnetic contactor and control relay of frequency inverter.
Insulation input/output signal	isolator	Due to frequency inverter insulation input/output signal, isolator can reduce inductive interference effectively
Improve frequency inverter input power factor	DC reactor/AC reactor	Apply to improve frequency inverter input power factor, please set DC reactor or AC reactor, when using large capacity power supply (above 600kW)
Reduce noise disturbance	Input noise filter	Input wiring can reduce noise flow into frequency inverter input power supply system. Please install the filter close to frequency inverter.
	Output noise filter	From frequency inverter output wiring reduce noise, please install the filter close to frequency inverter.
Machine stop running on setting time	Braking resistor	Braking unit will consume machine regenerated energy, which will reduce decrease time
	Braking unit	Braking unit and braking resistor combined using on machine, this will reduce motor decrease time.
Control frequency inverter operation from outside	Operator (small plastic-made device)	Control frequency setting and operation/stop operation by analog quantity instructions from distance.
	Operator (standard nickel clad made)	Control frequency setting and operation/stop operation by analog quantity instructions from distance.
Ensure frequency inverter sudden power failure compensation	Sudden power failure/compensate unit	To control power supply sudden failure compensation.
Setting and monitoring frequency and voltage from outside	Frequency meter	Outside setting and monitoring frequency device.
	Frequency setting device	
	Output voltmeter	Outside setting output volt device is PWM frequency inverter specialized voltmeter.
Adjust frequency instruction input and frequency meter, ampere meter full scale	Frequency instruction using thyrector baseboard	Install and control circuit terminal, input frequency instruction.
	Frequency meter full scale adjust resistor	Adjust frequency meter and ampere meter full scale.

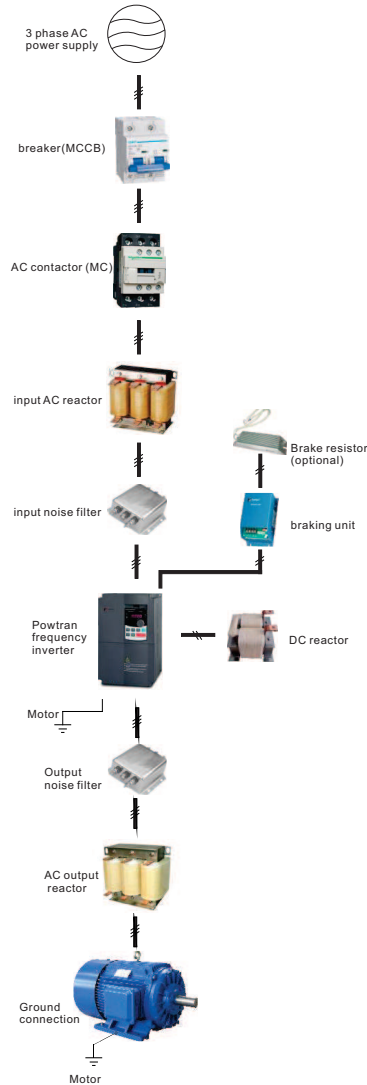

Various of expansion cards:

PI9000 is equipped with a variety of universal encoder expansion card (PG card), as an optional accessory, it is necessary part for the inverter closed-loop vector control, please select PG card according to the form of encoder output, the specific models are as follows:

Options	Description	Others
PI9000_PG1	Differential input PG card, without frequency dividing output	Terminal wiring
PI9000_PG3	UVW differential input PG card, without frequency dividing output	Terminal wiring
PI9000_PG4	Rotational transformer PG card	Terminal wiring
PI9000_PG5	OC input PG card, with 1:1 frequency dividing output	Terminal wiring

PI9000_PC1 the user programmable card is one integrated PLC function expansion card. The user can install the expansion card to make PI9000 series frequency inverter support simple PLC (User programmable) function. In addition, the card has integrated interface of the extended IO and universal communication.

Item	Specification	Description
Input terminal	5 road digital signal input	With isolation, support - 10 v ~ 10 v voltage input signal
	1 road analog voltage signal input	
Output terminal	2 road relay signal output	
	1 road analog signal output	
Communication	RS - 485 communication interface	

Braking unit and brake resistor:

Braking unit is mainly used in motor controlled by frequency inverter, which applied to and brand frequency inverter for the drop speed, brake positioning, hoisting and declining.

The inverter-controlled motor in rapid speed decrease and dropping in the operation, because of the load inertia, the kinetic energy will transferred into electrical energy and will be stored in the DC bus which will cause the jump of over-voltage or fault. Braking unit through the automatic detection of the DC bus voltage and self-switching, the renewable energy will be released into the braking resistor which ensures the drive to smooth control of the motor at various operating condition.



AC Reactor:

AC reactor can inhibit higher harmonic of frequency inverter input current, it can effective to improve inverter of power factor. Suggest that should use AC reactor in the following cases:

The ratio of the power supply capacity of frequency inverter used in and the frequency inverter capacity for more than 10:1.